

GRADALL®

XL 5200

HYDRAULIC EXCAVATOR



XL 5200

SPECIFICATIONS

Upperstructure Engine

Cummins 6BTA5.9 diesel, turbocharged and aftercooled, liquid cooled, 4 cycle, 6 cylinder, 359 cid (5.9L), 4.02" bore x 4.72" stroke (102mm x 120mm), 174:1 compression ratio.

174 hp (131kW) max. gross at 2100 rpm, 165 hp (123kW) gross at engine gov. speed of 2200 rpm, 163 hp (122kW) net at 2100 rpm, 512 ft.-lb. (694Nm) gross torque at 1500 rpm.

Altitude capability 10,000' (3050m). Derate 4% per 1000' (305m) above 10,000' (3050m).

Maximum slope: 45°

12 volt starter, 105 amp alternator, two SAE #C31-S 810 CCA batteries, two-stage dry type air cleaner with centrifugal pre-cleaner, ejector valve and service indicator, spin-on oil filter, spin-on fuel filter/water separator.

Fuel tank capacity: 86 gallons (326L)

Hydraulic System

PUMPS

Main Two load-sensing axial piston pumps; 0-60 GPM (0-227 L/min) each.

Swing Axial piston pump; 0-16 GPM (0-61 L/min).

Auxiliary Tandem gear pump for pilot control and cooling circuits; 20.6 GPM (78 L/min).

SYSTEM MONITOR

Electronic monitor in cab indicates low hydraulic fluid level, high hydraulic fluid temperature, and condition of return and suction filters.

SYSTEM SPECIFICATIONS

Four double acting cylinders

- 2 boom hoist: 4.75" ID, 3.25" rod (121mm x 83mm), 36.25" (921mm) stroke.
- 1 tool: 5" ID, 3.25" rod (127mm x 83mm), 25.3" (643mm) stroke.
- 1 telescope: 4" ID, 2.75" rod (102mm x 70mm), 14' (4.27m) stroke.

Four hydraulic motors

Swing, 54 hp (40kW); tilt, 28 hp (21kW); two crawler drives, 97 hp (72kW) each.

Operating pressures

Hoist	4300 psi (29,627kPa)
Tilt	3000 psi (20,670kPa)
Swing	5800 psi (39,962kPa)
Tool	4300 psi (29,627kPa)
Telescope	3500 psi (24,115kPa)
Crawler	4200 psi (28,965kPa)
Pilot system	480 psi (3,307kPa)

Rated bucket breakout force:

21,900 lbs. (97.5kN)

Rated boom force:

23,340 lbs. (103.9 kN)

Oil capacity

Reservoir 75 gallons (284L), system 100 gallons (379L). Pressurized reservoir with visual oil level gauges.

Filtration system

Combination of 8 micron and 10 micron in-line suction and return filters, plus 10 micron return filter, magnet and 100 mesh strainer in reservoir.

Fin and tube-type oil cooler, with thermal by-pass and relief valves.

Pressure compensated load-sensing valves with circuit reliefs in all valves.

Upperstructure Cab

All-weather cab with tinted safety glass windows, skylight, acoustical lining, four-way adjustable operator's seat, filtered fresh air heater and defroster. Front window slides to overhead storage. Mirrors located on both sides of machine.

CONTROLS

Two hydraulic joysticks (hoist & bucket, telescope & swing), one rocker switch (tilt) control upperstructure. Hydraulic joysticks mounted on arm rests, independently adjustable for individual operator comfort and convenience.

Two foot pedals/handles control crawler steering, travel and brakes; toggle switch for selection of crawler speed range.

Joysticks and pedals are self-centering; when controls are released, power for movement disengages and swing and crawler brakes set automatically.

Engine controls

Key operated ignition/starter switch, throttle, hour meter and air cleaner condition indicator. Electronic monitor indicates fuel level, low battery charge, coolant level and lube oil pressure, high coolant temperature, and engine rpm.

Swing

Independent closed loop swing circuit with axial piston pump and motor. Planetary transmission.

Swing speed: 6.1 rpm.

Swing brake

Automatic swing parking brake, spring-set hydraulic release. Dynamic braking provided by hydraulic system.

Undercarriage

Tractor type crawler with triple grouser heavy-duty pads. Sealed track links, lubricated and sealed idlers and rollers, hydraulic track tension adjustment, bolt on track guides, motor and hose guards, front and rear tow eyes.

Track length: 13'3" (4m)

Track pads: 23.6" (600mm) or 31.5" (800mm)

Overall width: 9'6" (2.9m) with 23.6" (600mm) pads. 10'2" (3.1m) with 31.5" (800mm) pads

Ground clearance: 19" (483mm)

Crawler Drive

Dual range high torque piston motor, 97 hp (72kW), powers each track. Three stage planetary drive with integral speed limiting valve and automatic spring-set hydraulic release wet disc parking brake.

Travel speed on flat, level surface—mph (km/hr):

Speed Selector	
High	0-2.2 (0-3.5)
Low	0-1.4 (0-2.2)

Travel speed range can be shifted while moving.

Gradeability: 100%, limited by engine lubrication requirements.

Drawbar pull: 39,900 lbs. (178kN)

Individual track control. Tracks counter-rotate to pivot machine around on centerline.

Electronically operated travel alarm mounted in counterweight area signals crawler movement in either direction.

Weight

Approximate working weight with 48" (1.22m) bucket, fuel tank half full:

	23.6" Pads (600mm)	31.5" Pads (800mm)
Weight	52,760 lb. (23,930 kg)	53,860 lb. (24,440 kg)
Bearing Pressure	8.1 psi (.57 kg/cm ²)	6.2 psi (.43 kg/cm ²)

GRADALL XL 5200 CRAWLER RATED LIFT CAPACITY OVER SIDE OR END-LB. (KG)

LOAD POINT HEIGHT		LOAD RADIUS						
		Minimum Radius	10' (3.0m)	15' (4.6m)	20' (6.1m)	25' (7.6m)	30' (9.1m)	Maximum Radius
Above Ground Level	20' (6.1m)	6570 @ 21'2" (2980 @ 6.5m)				5205 (2361)		4610 @ 27'0" (2091 @ 8.2m)
	15' (4.6 m)	13715 @ 13'9" (6221 @ 4.2m)		12365 (5609)	8495 (3853)	6065 (2751)		4630 @ 29'3" (2100 @ 8.9m)
	10' (3.0)	13235 @ 16'3" (6003 @ 5.0m)			9685 (4393)	6755 (3064)	4850 (2200)	4735 @ 30'4" (2148 @ 9.2m)
	Boom Level 8'6" (2.6m)	13235 @ 16'7" (6003 @ 5.1m)			9935 (4507)	6900 (3130)	4945 (2243)	4775 @ 30'7" (2166 @ 9.3m)
	5' (1.5m)	13385 @ 16'8" (6071 @ 5.1m)			10205 (4629)	7095 (3218)	5090 (2309)	4890 @ 30'7" (2218 @ 9.3m)
At Ground Level		13620 @ 15'6" (6178 @ 4.7m)			9795 (4443)	6995 (3173)	5085 (2307)	5085 @ 30'0" (2307 @ 9.1m)
Below Ground Level	5' (1.5m)	12820 @ 11'10" (5190 @ 3.6m)		11370 (5157)	8675 (3935)	6490 (2944)		5310 @ 28'5" (2409 @ 8.7m)
	10' (3m)	5135 @ 7'2" (2329 @ 2.2m)	8425 (3822)	8710 (3951)	7275 (3300)	5735 (2601)		5525 @ 25'9" (2506 @ 7.8m)
	15' (4.6m)	3840 @ 8'1" (1742 @ 2.5m)	5520 (2504)	6540 (2967)	5895 (2674)			5615 @ 21'5" (2547 @ 6.5m)
	20' (6.1m)	2820 @ 8'11" (1279 @ 2.7m)	3555 (1613)					4770 @ 14'1" (2164 @ 4.3m)

CAUTION: All rated loads are based on the machine being stationary and level on a firm supporting surface. For safe working loads, the user must make due allowance for his particular job conditions, such as soft or uneven ground, out of level conditions, side loads, hazardous conditions, experience of personnel, etc. The operator and other personnel must fully acquaint themselves with the Operator's Manual furnished by the manufacturer before operating this machine, and rules for safe operation of equipment must be adhered to at all times.

All loads shown are limited by hydraulic lift capacity rather than stability.

Loads are in compliance with SAE Standard J-1097 NOV 88. They do not exceed 87% of hydraulic lifting capacity or 75% of tipping capacity.

The rated lift capacity is based on the machine being equipped with 7000 lb. (3175kg) counterweight, standard 23.6" (600mm) or 31.5" (800mm) pads, and 8095-6001 48" (122cm) excavating bucket weighing 1290 lbs. (585kg). For other buckets adjust the listed capacities as follows:

- 8095-6002 72" (1.83m) ditching – subtract 90 lbs (41kg)
- 8095-6006 72" (1.83m) ditching – add 5 lbs (2kg)
- 8095-6003 48" (1.22m) pavement removal – subtract 170 lbs (77kg)
- 8095-6005 36" (910mm) excavating – add 250 lbs (113kg)
- 8095-6004 28" (710mm) excavating – add 410 lbs (186kg)

The load point is located on the bucket pivot point, including loads listed for maximum radius.

Do not attempt to lift or hold any load greater than these rated values at specified load radii and heights. The weight of slings and any auxiliary lifting devices must be deducted from the rated load to determine the net load that may be lifted.

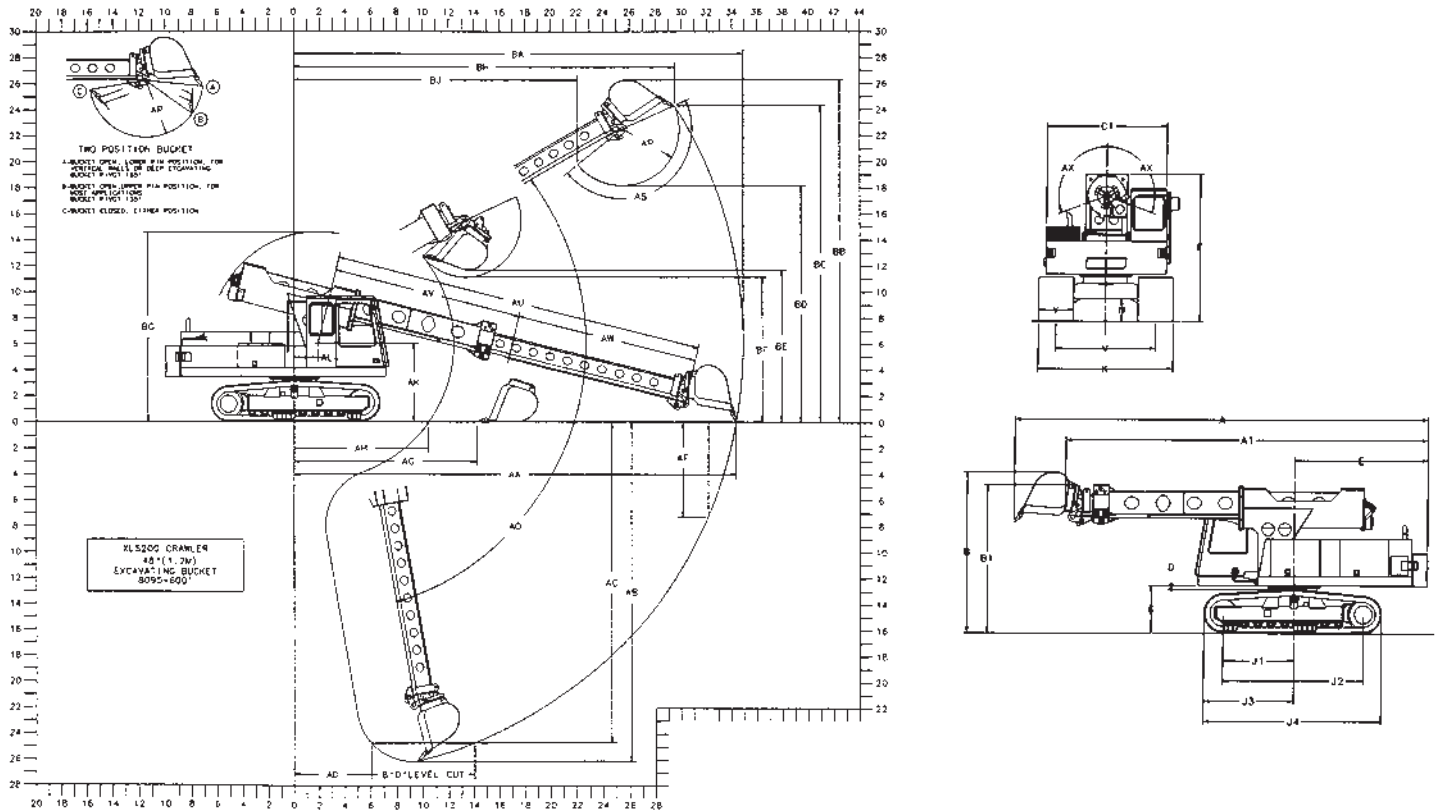

Shown with 8095-6001 48" (1.22m) excavating bucket

Metric units m unless otherwise noted.

- A** Overall length with bucket: 30'10" (9.4)
- A1** Overall length without bucket: 27'1" (8.2)
- B** Overall height with bucket: 11'10" (3.6)
- B1** Overall height without bucket: 10'10" (3.3)
- C1** Width of upperstructure: 9'0" (2.7)
- D** Minimum clearance, upperstructure to undercarriage: 4" (102mm)
- E** Swing clearance, rear of upperstructure: 10'0" (3.0)
- F** Top of cradle to groundline: 10'10" (3.3)
- G** Clearance, upperstructure to groundline: 42" (1.1)
- J1** Axis of rotation to centerline of drive sprockets: 5'3" (1.6)
- J2** Nominal distance between centerlines of drive sprockets and idlers: 10'5" (3.2)
- J3** Axis of rotation to end of track assembly: 6'8" (2.0)
- J4** Nominal overall length of track assembly: 13'3" (4.0)
- K** Width of crawler with 23.6" (600mm) pads: 9'6" (2.9)
Width of crawler with 31.5" (800mm) pads: 10'2" (3.1)
- N** Ground clearance (per SAE J1234): 19" (483mm)
- V** Track gage, roller centerline to roller centerline: 7'6" (2.3)
- Y** Width of crawler track assembly: 31.5" (800mm)
- AA** Maximum radius at groundline (165° pivot): 34'4" (10.5)
- AB** Maximum digging depth (165° pivot) – end: 26'1" (7.9)
- AC** Maximum depth for 8' level cut – end: 24'8" (7.5)
- AD** Minimum radius of 8' level cut at depth "AC" – end: 6'0" (1.8)
- AF** Maximum depth of vertical wall which can be excavated: 7'3" (2.2)
- AG** Minimum level cut radius with bucket flat on groundline: 14'2" (4.3)
- AH** Minimum radius at groundline: 10'5" (3.2)
- AK** Boom pivot to groundline: 6'1" (1.8)
- AL** Boom pivot to axis of rotation: 22.5" (571mm)
- AP** Bucket tooth radius: 52" (1.3)
- AQ** Boom pivot angle: 30° Up & 80° Down
- AS** Bucket pivot angle: 135° & 165°
- AU** Maximum telescoping boom length (boom pivot to bucket pivot): 28'8" (8.7)
- AV** Minimum telescoping boom length (boom pivot to bucket pivot): 14'8" (4.5)
- AW** Telescoping boom travel: 14'0" (4.3)
- AX** Boom tilt angle (both sides of center): 110°
- BA** Maximum radius of working equipment (165° pivot): 34'11" (10.6)
- BB** Maximum height of working equipment: 26'4" (8.0)
- BC** Maximum bucket tooth height: 24'4" (7.4)
- BD** Minimum clearance of bucket teeth with bucket pivot at maximum height: 18'2" (5.5)
- BE** Minimum clearance of fully curled bucket at maximum boom height (165° pivot): 11'9" (3.6)
- BF** Minimum clearance of bucket teeth at maximum boom height: 11'2" (3.4)
- BG** Maximum height of working equipment with bucket below groundline: 14'8" (4.5)
- BH** Radius of bucket teeth at maximum height (165° pivot): 29'5" (9.0)
- BJ** Minimum radius of bucket teeth at maximum bucket pivot height (165° pivot): 22'1" (6.7)

Transport dimensions without attachment
 Length: 27'1" (8.2)
 Height: 10'10" (3.3)
 Width: on 23.6" (600mm) pads - 9'6" (2.9)
 on 31.5" (800mm) pads - 10'2" (3.1)

Units shown may have optional equipment

Optional Equipment

Work lights: 2 floodlights on boom cradle, 4 floodlights on upperstructure cab, 2 floodlights on left front upperstructure shrouding.

Windshield washer and wiper.

Vandalism protection kit: Lexan cab windows, locking reservoir cap and sight gauge cover.

Spark arrestor.

Revolving beacon.

Cold start package for engine: includes ether start kit and additional battery.

Air conditioning.

Inside hose trough with additional hosing and piping for pneumatic or hydraulic powered attachments.

360° continuous boom tilt.

Telestick attachment.

Blank attachment adapter.

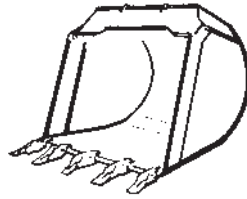

		Cu. yd.	m3
8095-6024	15" (381mm) Excavating bucket	1/4	.19
8095-6004	28" (710mm) Excavating bucket	5/8	.47
8095-6005	36" (914mm) Excavating bucket	7/8	.66
8095-6001	48" (1,22m) Excavating bucket	1-1/4	.96

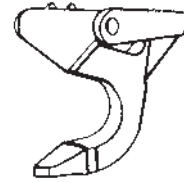

8095-6009 Single-tooth ripper

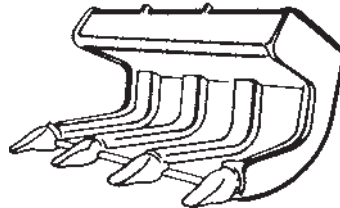

8095-6003	48" (1.22m) Pavement removal bucket		
8095-6017	60" (1.52m) Rock bucket	1 3/8	1.04

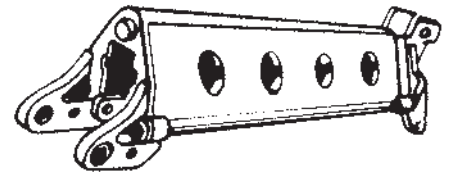

8095-5012 6' (1.8m) Boom extension
8095-5013 8' (2.4m) Boom extension
8065-5014 12' (3.7m) Boom extension

Telestick package provides 50'4" (15.3m) surface reach – contact factory for details.

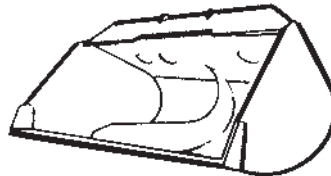

		Cu. yd.	m3
8095-6025	24" (610mm) Ditching bucket	1/2	.38
8095-6036	66" (1.68m) Ditching bucket	1-1/2	1.14
8095-6002	72" (1.83m) Ditching bucket	1-3/4	1.34
8095-6006	72" (1.83m) Ditching bucket with continuous radius	1-7/16	1.09

It is Gradall Policy to continually improve its products. Therefore designs, materials and specifications are subject to change without notice and without incurring any liability on units already sold. Units shown may have optional equipment.

GRADALL®

406 Mill Ave. SW, New Philadelphia, Ohio 44663
Phone: 330-339-2211 Fax: 330-339-8468
www.gradall.com



Certified ISO 9001

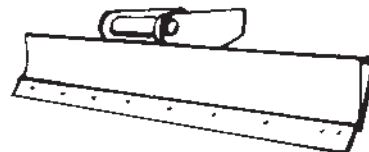

8095-6023 96" (2.4m) Grading blade

ATTACHMENTS

Buckets fabricated of steel plate, with high strength, low alloy cutting edges and wear strips. Standard attachments available for wide range of applications. Capacities shown are SAE heaped. All digging attachments are reversible.

TWO POSITION BUCKET

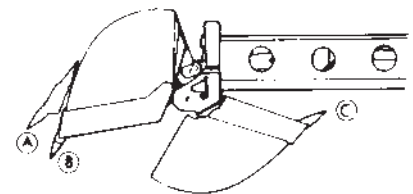

A - Bucket open, lower pin position, for vertical walls or deep excavating. Bucket pivot 165°.

B - Bucket open, upper pin position, for most applications. Bucket pivot 135°.

C - Bucket closed, either pin position.